

Gripper

RADIAL MOTION Double Acting

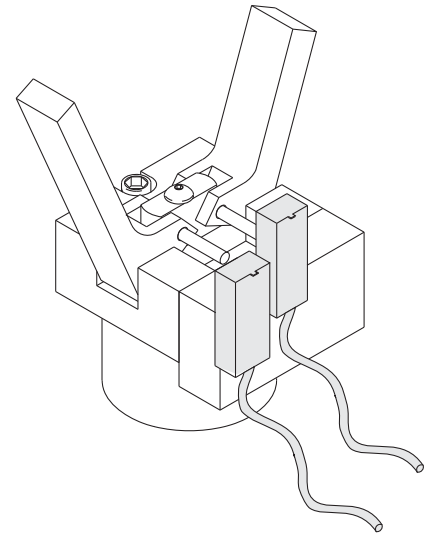

B-3S



Proximity sensors
preassembled for
open & closed positions
(see page 17)

TECHNICAL DATA:

Weight	3.3 lbs
Max Rec. Load	18 lbs
Force @ 80 psi	55 lbs @ F
Operating Pressure	60-100 PSI

